

A Leading Energy Solution  
Manufacturer Vendor

FLYFINE

# User Manual Hybrid Solar Inverter

- 6kW Inverter ◦
- 7kW Inverter ◦
- 8kW Inverter ◦
- 10kW Inverter ◦
- 12kW Inverter ◦

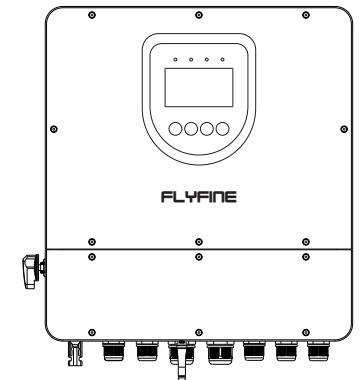

 Flyfine Digital Energy Co., Ltd.

 +86-18924268899

 Sales@flyfinetech.com

 www.flyfinebattery.com



www.flyfinebattery.com



**TABLE OF CONTENTS**

**1. ABOUT THIS MANUAL** ..... 03

    1.1 Purpose ..... 03

    1.2 Scope ..... 03

**2. SAFETY INSTRUCTIONS** ..... 03

**3. INTRODUCTION** ..... 04

    3.1 Features ..... 04

    3.2 Basic System Architecture ..... 05

    3.3 Product Overview ..... 06

**4. INSTALLATION** ..... 07

    4.1 Unpacking And Inspection ..... 07

    4.2 Preparation ..... 07

    4.3 Mounting The Unit ..... 07

    4.4 Battery Connection ..... 08

    4.5 AC Input/Output Connection ..... 10

    4.6 PV Connection ..... 12

    4.7 Current Transformer Connection ..... 15

    4.8 Final Assembly ..... 16

    4.9 Communication Connection ..... 16

    4.10 Dry Contact Signa ..... 18

**5. OPERATION** ..... 19

    5.1 Power ON/OFF ..... 19

    5.2 Operation And Display Panel ..... 19

    5.3 LCD Display Icons ..... 20

    5.4 LCD operation flow chart ..... 22

    5.5 LCD Display Setting ..... 22

        5.5.1 Detail Page ..... 22

        5.5.2 System Setting Page ..... 24

        5.5.3 Battery Setting Page ..... 24

        5.5.4 Work Mode Setting ..... 27

        5.5.5 Time Of Use Page ..... 29

        5.5.6 Basic Setting Page ..... 29

        5.5.7 Grid Setting Page ..... 30

        5.5.8 History Error Page ..... 30

    5.6 Fault Reference Code ..... 31

    5.7 Warning Indicator ..... 32

**6. SPECIFICATIONS** ..... 33

    Table 1 Line Mode Specifications ..... 33

    Table 2 Inverter Mode Specifications ..... 33

    Table 3 Two Load Output Power ..... 34

    Table 4 Charge Mode Specifications ..... 34

    Table 5 Grid-Tie Operation ..... 35

    Table 6 General Specifications ..... 35

**7. TROUBLE SHOOTING** ..... 36

**\*APPENDIX I: PARALLEL FUNCTION**

- 1. INTRODUCTION** . . . . . 37
- 2. MOUNTING THE UNIT** . . . . . 37
- 3. WIRING CONNECTION** . . . . . 37
- 4. PARALLEL CONNECTION** . . . . . 38
  - 4.1 Parallel Operation in Single phase . . . . . 38
  - 4.2 Support 3-phase equipment . . . . . 41
- 5. PV CONNECTION** . . . . . 42
- 6. LCD SETTING AND DISPLAY** . . . . . 42
- 7. COMMISSIONING** . . . . . 43
  - 7.1 Parallel in single phase . . . . . 43
  - 7.2 Support three-phase equipment . . . . . 43
- 8. TROUBLE SHOOTING** . . . . . 45

**\*APPENDIX II: WI-FI CONNECTION INSTRUCTIONS**

- 1. WIRELESS WI-FI DISTRIBUTION NETWORK** . . . . . 46
  - 1.1 APP Download . . . . . 46
  - 1.2 Registered Account . . . . . 46
- 2. SUPPORTING NETWORK AND ADDING DEVICE** . . . . . 46
  - 2.1 Wi-Fi collector connection Router . . . . . 46
  - 2.2 Add Device . . . . . 47
- 3. COLLECTOR FAULT DIAGNOSE AND INDICATOR LIGHT JUDGMENT** . . . . . 49
  - 3.1 Collector Fault Diagnose . . . . . 49
  - 3.2 Collector Indicator Status . . . . . 49

## 1.ABOUT THIS MANUAL

### 1.1 Purpose

This manual describes the assembly, installation, operation and troubleshooting of this unit. Please read this manual carefully before installations and operations, Keep this manual for future reference.

### 1.2 Scope

This manual provides safety and installation guidelines as well as information on tools and wiring.

## 2.SAFETY INSTRUCTIONS

### WARNING

- This chapter contains important safety and operating instructions. Read and keep this manual for future reference.
- Only qualified service persons are able to service this device. If errors still persist after following troubleshooting table, please send this inverter/charger back to local dealer or service center for maintenance.
- Because this inverter is non-isolated, only three types of PV modules are acceptable: single crystalline, poly crystalline with class A-rated and CIGS modules. To avoid any malfunction, do not connect any PV modules with possible current leakage to the inverter. For example, grounded PV modules will cause current leakage to the inverter, When using CIGS modules, please be sure no grounding.

### CAUTION

- To reduce risk of injury, charge only deep-cycle lead acid type rechargeable batteries and LiFePO4 batteries. Other types of batteries may burst, causing personal injury and damage.
- Only qualified personnel can install this device with battery.
- Never charge a frozen battery.
- It's required to use PV junction box with surge protection. Otherwise, it will caused damage on inverter when lightning occurs on PV modules.

1. Before using the unit, read all instructions and cautionary markings on the unit, the batteries and all appropriate sections of this manual.
2. Do not disassemble the unit. Take it to a qualified service center when service or repair is required. Incorrect reassembly may result in a risk of electric shock or fire.
3. To reduce risk of electric shock, disconnect all wirings before attempting any maintenance or cleaning. Turning off the unit will not reduce this risk.
4. For optimum operation of this inverter/charger, please follow required spec to select appropriate cable size. It's very important to correctly operate this inverter/charger.
5. Be very cautious when working with metal tools on or around batteries. A potential risk exists to drop a tool to spark or short circuit batteries or other electrical parts and could cause an explosion.
6. Please strictly follow installation procedure when you want to disconnect AC or DC terminals. Please refer to installation section of this manual for the details.
7. One piece of 400A fuse is provided as over-current protection for the battery supply.
8. This inverter/charger should be connected to a permanent grounded wiring system. Be sure to comply with local requirements and regulation to install this inverter.
9. Never cause AC output and DC input short circuited. Do not connect to the mains when DC input short circuits.

### 3. INTRODUCTION

This is a multi-function inverter/charger, combining functions of inverter, solar charger and battery charger to offer uninterruptible power support with portable size. Its comprehensive LCD display offers user-configurable and easy-accessible button operation such as battery charging current, AC/solar charger priority, and acceptable input voltage based on different applications.

#### 3.1 Features

1. Pure sine wave inverter.
2. Configurable input voltage range for home appliances and personal computers via LCD setting.
3. Configurable battery charging current based on applications via LCD setting.
4. Configurable AC/Solar Charger priority via LCD setting.
5. Compatible to mains voltage or generator power.
6. Auto restart while AC is recovering.
7. Overload/ Over temperature/ short circuit protection.
8. Smart battery charger design for optimized battery performance.
9. Cold start function.

- 10.It can realize the simultaneous use of less than six machines.
- 11.Built-in Wi-Fi for mobile monitoring (APP required), can connect and communicate with the lithium battery.
- 12.The allowable charge and discharge time can be set.

**3.2 Basic System Architecture**

The following illustration shows basic application for this inverter/charger. It also includes following devices to have a complete running system:

- 1.Battery,Generator or Utility.
- 2.PV modules.

Consult with your system integrator for other possible system architectures depending on your requirements.This inverter can power all kinds of appliances in home or office environment, including motor-type appliances such as tube light, fan, refrigerator and air conditioner.

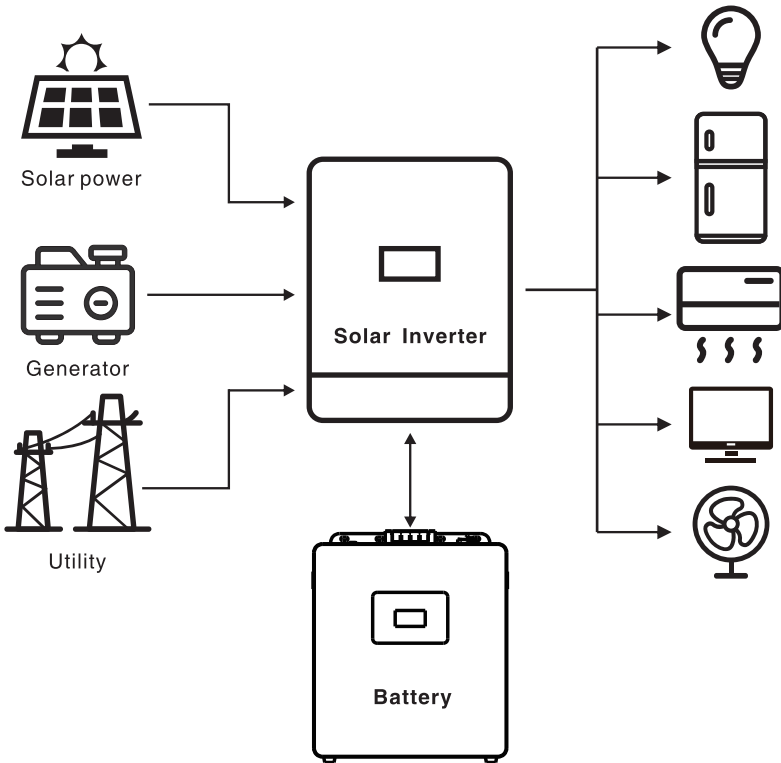

### 3.3 Product Overview

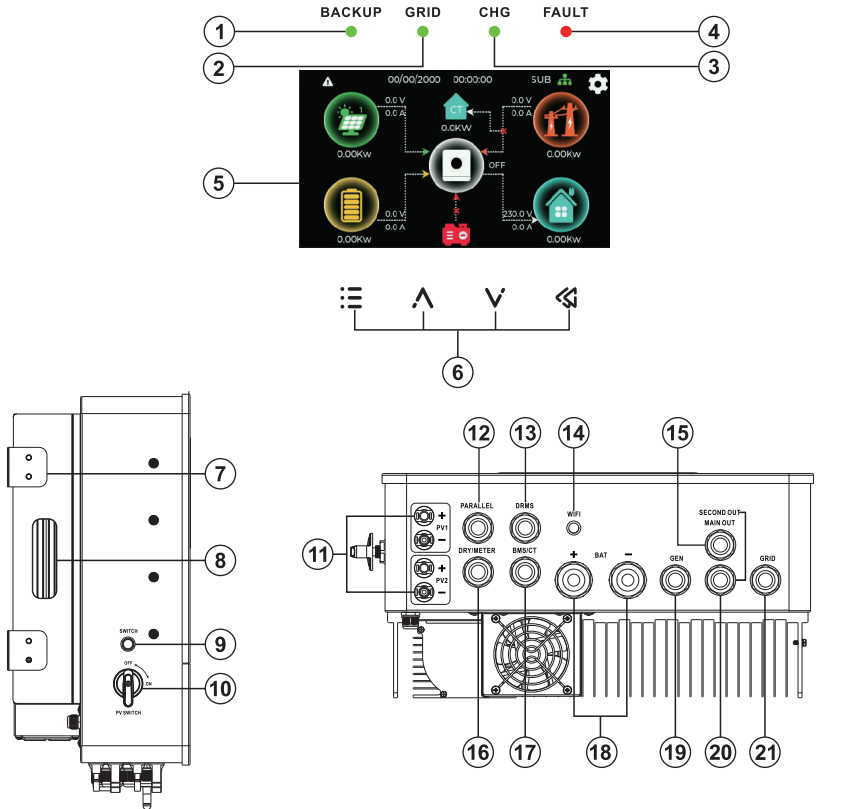

- 1.Back up indicator
- 2.Grid indicator
- 3.Charge indicator
- 4.Fault indicator
- 5.LCD display
- 6. Function buttons
- 7.Wall rack
- 8.lifting handle
- 9.Power on/off switch
- 10.PV switch
- 11.PV1 and PV2 input
- 12.Parallel port
- 13.DRMS port
- 14.WIFI communication
- 15.Main output
- 16.DRY/METER port
- 17.Battery communication/RS-485 port /Current Transformer
- 18.Battery input
- 19.Generator
- 20.Second output
- 21.GRID

## 4.INSTALLATION

### 4.1 Unpacking And Inspection

Before installation, please inspect the unit. Be sure that nothing inside the package is damaged. You should have received the following items inside of package:

- ▶The unit x 1
- ▶User manual x 1
- ▶Wall-mounted bracket x 4
- ▶WIFI x 1
- ▶Current Transformer x1
- ▶Panel wrench x 1
- ▶Ring terminal x 9
- ▶Parallel communication line x 1
- ▶M6 round-head screw x 8
- ▶Expansion screw x 4

\*NOTE:

Due to differences in machine models, there may be slight variations in accessories; please refer to the actual items received. In case of any updates to the accessories, no separate notification will be given.

### 4.2 Preparation

Before connecting all lines, remove the screws under the machine and remove the bottom cover plate.

### 4.3 Mounting The Unit

Consider the following points before selecting where to install:

- 1.Do not mount the inverter on flammable construction materials.
- 2.Mount on a solid surface.
- 3.Install this inverter at eye level in order to allow the LCD display to be read at all times.
- 4.For proper air circulation to dissipate heat, allow a clearance of approx.20 cm to the side and approx. 50 cm above and below the unit.
- 5.The ambient temperature should be between 0°C and 55°C to ensure optimal operation.
- 6.The recommended installation position is to be adhered to the wall vertically.
- 7.Make sure that other objects and surfaces are left with enough space from the machine to ensure adequate heat dissipation and that there is enough room to remove the wires.

#### **⚠ CAUTION**

- Suitable for mounting on concrete or other non-combustible surface only.

Installation steps for wall-mounted brackets:

- 1.First, use 8 M6 round-head screws to install the 4 wall-mounted brackets on the machine.

2. Drill four holes in the wall; the positions are determined according to the positions of the wall-mounted brackets, and the recommended depth is 40~45mm.
3. Secure the machine to the wall via the wall-mounted brackets using 4 M5 expansion screws.

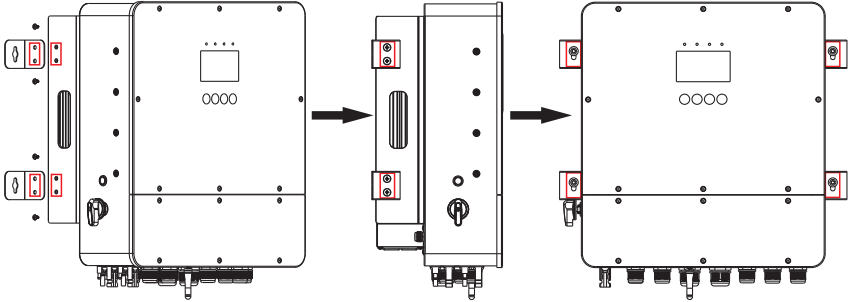

#### 4.4 Battery Connection

**CAUTION**

- For safety operation and regulation compliance, it's requested to install a separate DC over-current protector or disconnect device between battery and inverter. It may not be requested to have a disconnect device in some applications, however, it's still requested to have over-current protection installed. Please refer to typical amperage in below table as required fuse or breaker size.

**WARNING**

- All wiring must be performed by a qualified personnel.
- It's very important for system safety and efficient operation to use appropriate cable for battery connection. To reduce risk of injury, please use the proper recommended cable as below.

Recommended battery cable size:

Model	Wire size	Cable(mm <sup>2</sup> )	Torque value(max)
6KW/7KW/8KW	1x 2AWG	25	2N · m
10KW/12KW	1x 0AWG	53	2N · m

Please follow below steps to implement battery connection:

1. Remove insulation sleeve 18 mm for positive and negative conductors.
2. Suggest to put bootlace ferrules on the end of positive and negative wires with a proper crimping tool.

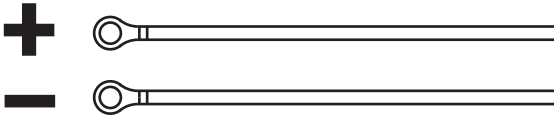

3. Connect all battery packs as below chart.

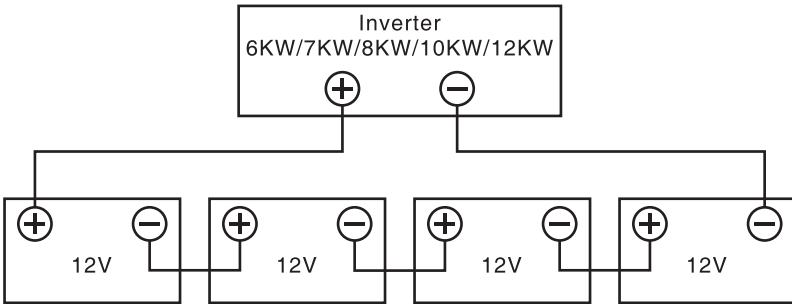

4. Insert the battery wires flatly into battery connectors of inverter and make sure the bolts are tightened with torque of 2 N · m in clockwise direction. Make sure polarity at both the battery and the inverter/charge is correctly connected and conductors are tightly screwed into the battery terminals.

Recommended tool: #2 Pozzi Screwdriver

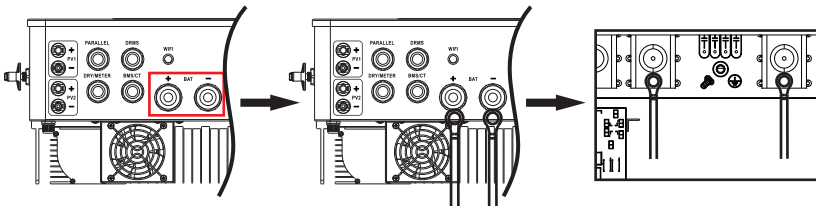

**! CAUTION**

- Before making the final DC connection or closing DC breaker/disconnector, be sure positive (+) must be connected to positive (+) and negative (-) must be connected to negative (-).

**! WARNING**

- Installation must be performed with care due to high battery voltage in series.

### 4.5 AC Input/Output Connection

**⚠ CAUTION**

- Before connecting to AC input power source, please install a separate AC breaker between inverter and AC input power source. This will ensure the inverter can be securely disconnected during maintenance and fully protected from over current of AC input. The recommended spec of AC breaker is 50A for 6KW, 60A for 7KW, 65A for 8KW, 85A for 10KW, 100A for 12KW.
- There are two terminal blocks with “IN” and “OUT” markings. Please do NOT mis-connect input and output connectors.

**⚠ WARNING**

- All wiring must be performed by a qualified personnel.
- It's very important for system safety and efficient operation to use appropriate cable for AC input connection. To reduce risk of injury, please use the proper recommended cable size as below.

Suggested cable requirement for AC wires:

Model	Wire size	Cable(mm <sup>2</sup> )	Torque value(max)
6KW/7KW/8KW	10AWG	6	1.2N · m
10KW/12KW	8AWG	6	1.2N · m

Please follow below steps to implement AC input/output connection:

1. Before making AC input/output connection, be sure to open DC protector or disconnect first.
2. Remove insulation sleeve 10mm for six conductors. And shorten phase L and neutral conductor N 3 mm.
3. Insert AC input wires according to polarities indicated on terminal block and tighten the terminal screws. Be sure to connect PE protective conductor (⊕) first.

- L→LINE(brown or black)
- N→Neutral(blue)
- ⊕ →Ground (green&yellow)

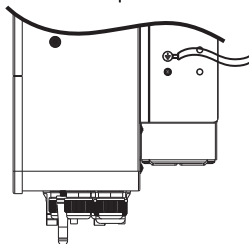

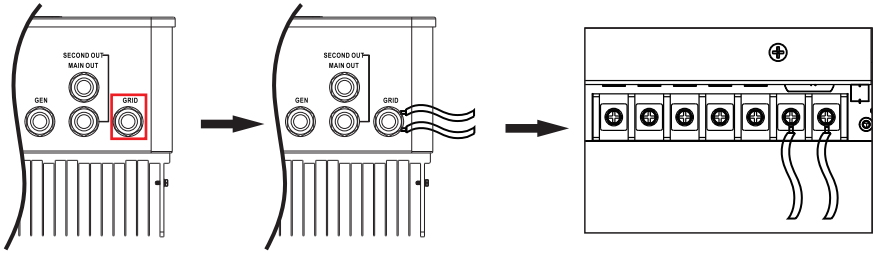

**⚠ WARNING**

- Be sure that AC power source is disconnected before attempting to hardwire it to the unit.

4.Then, insert AC output wires according to polarities indicated on terminal block and tighten terminal screws.

L→LINE(brown or black)

N→Neutral(blue)

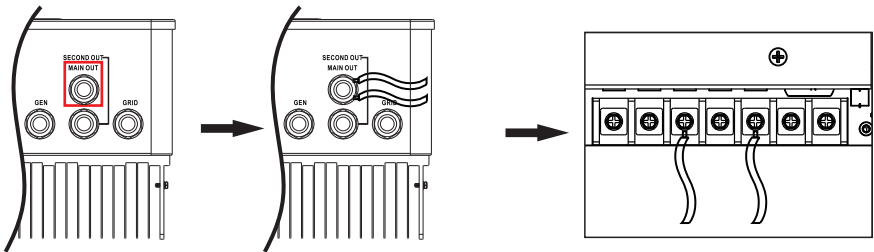

5.Make sure the wires are securely connected.

**⚠ CAUTION**

- Appliances such as air conditioner are required at least 2~3 minutes to restart because it's required to have enough time to balance refrigerant gas inside of circuits. If a power shortage occurs and recovers in a short time, it will cause damage to your connected appliances. To prevent this kind of damage, please check manufacturer of air conditioner if it's equipped with time-delay function before installation. Otherwise, this inverter/charger will trig overload fault and cut off output to protect your appliance but sometimes it still causes internal damage to the air conditioner.

### 4.6 PV Connection

**⚠ CAUTION**

- Before connecting to PV modules, please install separately a DC circuit breaker between inverter and PV modules.
- It's required to use PV junction box with surge protection. Otherwise, it will cause damage on inverter when lightning occurs on PV modules.

**⚠ WARNING**

- Because this inverter is non-isolated, only three types of PV modules are acceptable: single crystalline and poly crystalline with class A-rated and CIGS modules.
- To avoid any malfunction, do not connect any PV modules with possible current leakage to the inverter. For example, grounded PV modules will cause current leakage to the inverter, When using CIGS modules, please be sure NO grounding.
- It's very important for system safety and efficient operation to use appropriate cable for PV module connection. To reduce risk of injury, please use the proper recommended cable size as below.

Model	Wire size	Cable(mm <sup>2</sup> )	Torque value(max)
6KW/7KW/8KW/10KW/12KW	1×10AWG	6	1.2N · m

**PV Module Selection:**

When selecting proper PV modules, please be sure to consider below parameters:

- 1.Open circuit Voltage (Voc) of PV modules not exceeds max. PV array open circuit voltage of inverter.
- 2.Open circuit Voltage (Voc) of PV modules should be higher than min. battery voltage.

Inverter Model	6KW/7KW/8KW/10KW/12KW
Max. PV Array Open Circuit Voltage	520Vdc
PV Array MPPT Voltage Range	50Vdc~500Vdc

Take 700Wp PV module as an example. After considering above two parameters, the recommended module configurations are listed as below table.

Solar Panel Spec. (reference)	Solar input	Q'ty of panels	Total input power
	(Min in serial: 3 pcs, max. in serial: 9 pcs)		
-700Wp	3 pcs in serial	3 pcs	2100W
-Vmp: 40.5V	7 pcs in serial	7 pcs	4900W
-Imp: 17.29A	9 pcs in serial	9 pcs	6300W
-Voc: 48.6V	7 pieces in serial and 2 sets in parallel	14 pcs	9800W
-Isc: 18.32A	9 pieces in serial and 2 sets in parallel	18 pcs	12600W
-Cells:288(144×2)	7 pieces in serial and 3 sets in parallel	21 pcs	14700W

PV Module Wire Connection

Step 1: Check the input voltage of PV array modules. The acceptable input voltage of the inverter is 50 VDC ~520VDC, Please make sure that the maximum current load of each PV input connector is 18A.

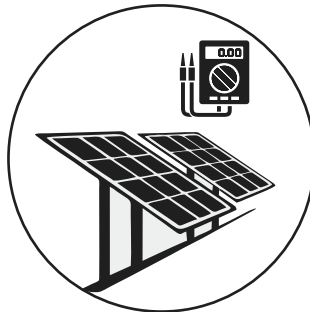





**⚠ CAUTION**

- Exceeding the maximum input voltage can destroy the unit ! check the system before wire connection.

Step 2: Disconnect the DC circuit breaker.

Step 3: Assemble provided PV connectors with PV modules by the following below steps.

Components for PV connectors and Tools:

Female connector housing		Male terminal	
Female terminal		Crimping tool and spanner	
Male connector housing			

Cable preparation and connector assembly process:

Strip one cable 8 mm on both end sides and be careful NOT to nick conductors.

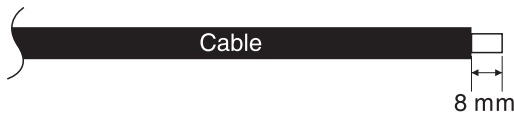

Insert striped cable into female terminal and crimp female terminal as shown below charts.



Insert assembled cable into female connector housing as shown below charts.

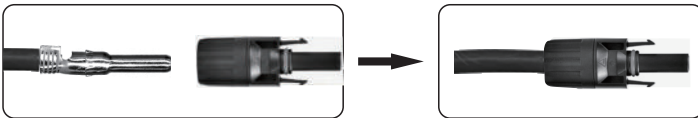

Insert striped cable into male terminal and crimp male terminal as shown below charts.



Insert assembled cable into male connector housing as shown below charts.

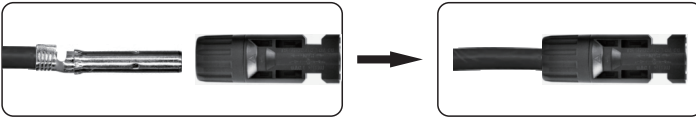

Then, use spanner to screw pressure dome tightly to female connector and male connector as shown below.

Step 4: Check correct polarity of connection cable from PV modules and PV input connectors. Then, connect positive pole (+) of connection cable to positive pole (+) of PV input connector, Connect negative pole (-) of connection cable to negative pole (-) of PV input connector.

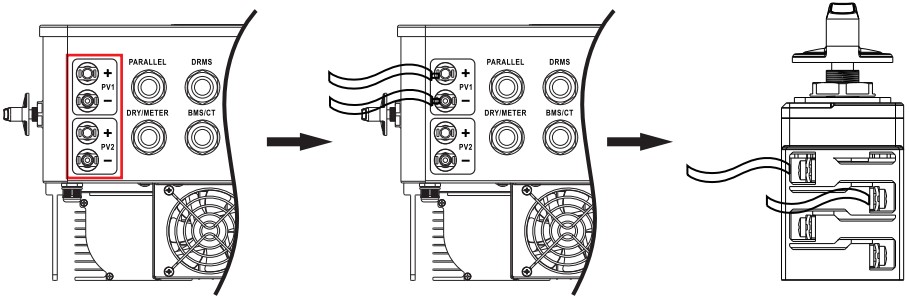

### 4.7 Current Transformer Connection

Connect the CT connector at the bottom of the machine. Connect the left terminal to the positive terminal and the right terminal to the negative terminal.

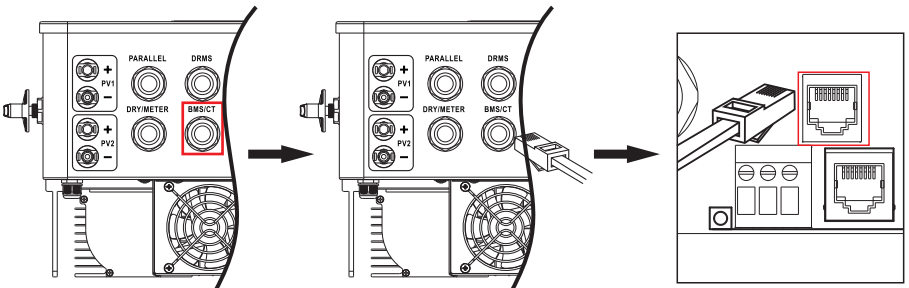

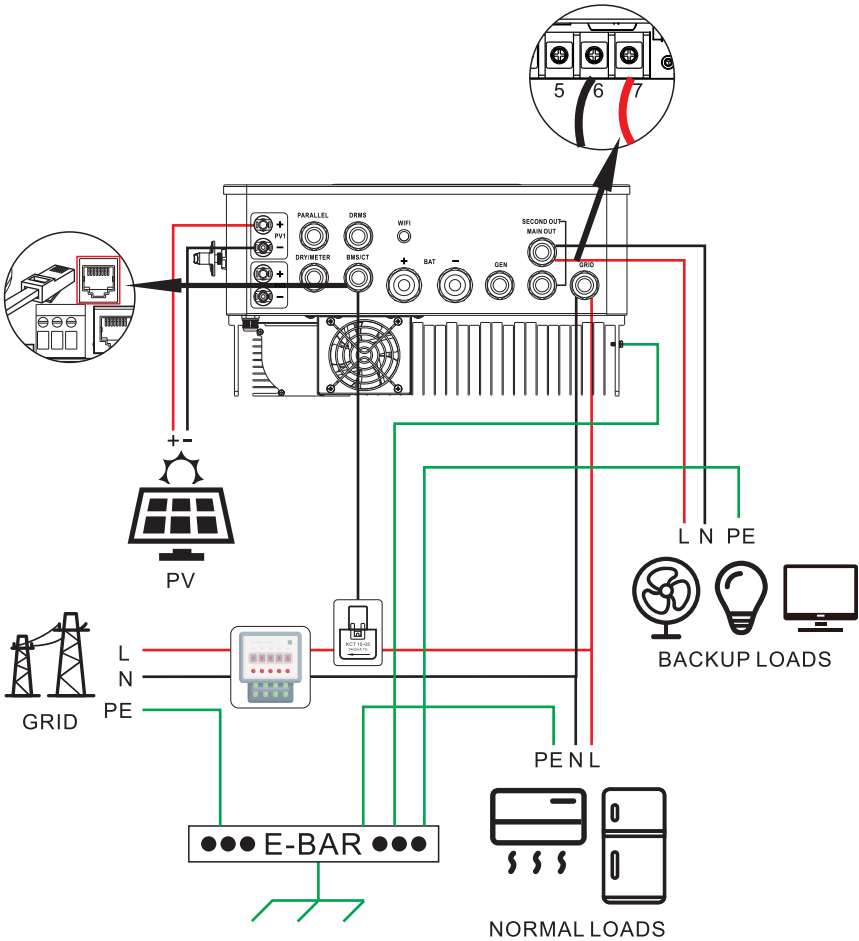

### 4.8 Final Assembly

After all wires are connected, put the bottom cover back in place and tighten the screws.

### 4.9 Communication Connection

1. Wi-Fi cloud communication:

Please use supplied communication cable to connect to inverter and Wi-Fi module. Download APP and installed from APP store, and refer to "Wi-Fi Plug Quick Installation Guideline" to set up network and registering. The inverter status would be shown by mobile phone APP or webpage of computer.

2.Battery communication

The communication between the battery and the inverter can be realized through the battery communication interface, so that the inverter and the lithium battery can exchange information (Baud rate:9600).

3.Lithium battery and inverter connection:

Use power cables, communication cables for lithium batteries, and inverters to connect.

Note: Lithium battery and inverter positive and negative positions, check the correct installation:The RJ45 connector of the communication cable connects to the BMS port of the inverter, and the other RJ45 connector connects to the RS485 port of the lithium battery; Before connecting, make sure that the lithium battery and inverter are turned of.(It is recommended to install a circuit breaker for the power cables of the lithium battery and the inverter battery interface. Otherwise, a spark may occur.)

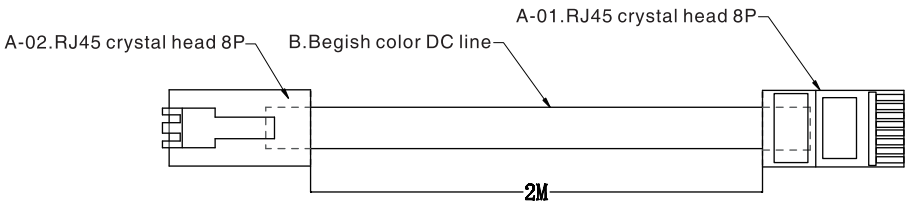

CONNECTION METHOD	
A-01	RS485
1	RS485-B
2	RS485-A
3	GND
Empty PIN is not connected	

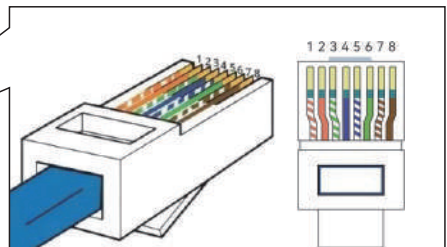

The lithium battery communication cable interface is shown in the figure

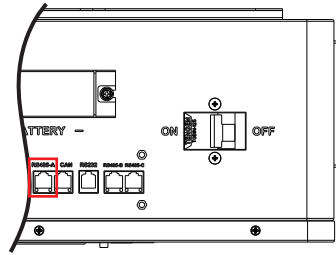
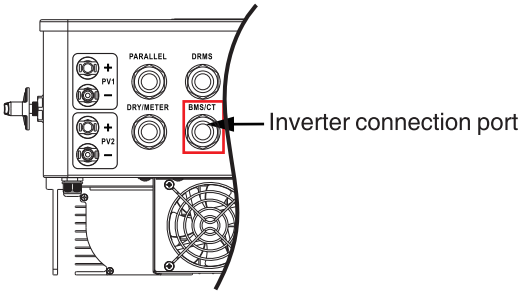

Lithium battery connection diagram

### 4.10 Dry Contact Signa

There is one dry contact (3A/250VAC) available on the rear panel. it could be used to deliver signal to external device when battery voltage reaches warning level.

Unit Status	Condition	Dry contact port:		
		NC&C	NO&C	
Power Off	Unit is off and no output is powered	Close	Open	
Power On	Mains mode	Close	Open	
	Non-mains mode	Battery voltage < stop discharge voltage or stop discharge SOC	Open	Close
		Battery voltage > Re-discharge voltage or Re-discharge SOC	Close	Open

## 5. OPERATION

### 5.1 Power ON/OFF

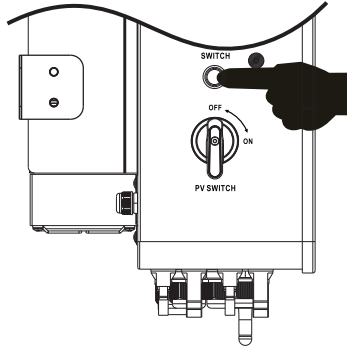

Once the unit has been properly installed, simply press on switch (located on the button of the case) to turn on the unit.

### 5.2 Operation And Display Panel

The operation and display panel, shown in below chart, is on the front panel of the inverter. It includes second indicators, four function keys and a LCD display, indicating the operating status and input/output power information.

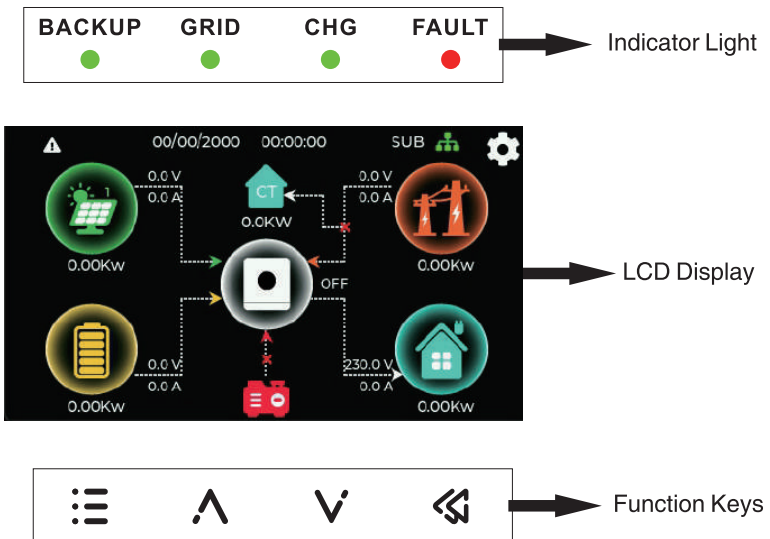

Indicator Light

Indicator Light			Messages
<b>BACKUP</b> ●	Green	Solid On	Output is powered by battery or PV in battery mode.
<b>GRID</b> ●	Green	Solid On	Output is powered by utility in Line mode.
<b>CHG</b> ●	Green	Solid On	Battery is fully charged.
		Flashing	Battery is charging.
<b>FAULT</b> ●	Red	Solid On	Fault occurs in the inverter.
		Flashing	Warning condition occurs in the inverter.

Function keys







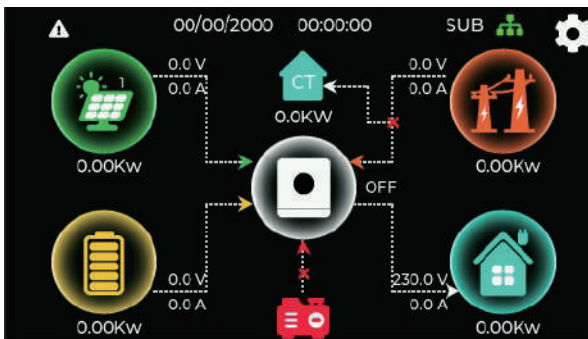

Function key	Description
☰ ESC	To exit setting mode
▲ UP	To go to previous selection
▼ DOWN	To go to next selection
↵ ENTER	To confirm the selection in setting mode or enter setting mode

5.3 LCD Display Icons

Main Screen

The LCD is touchscreen, below screen shows the overall information of the inverter.



Icon	Function description
	The icon indicates whether the system is under normal operation or not, displaying "ON" for normal status.
	Indicate each PV input voltage, current, power.
	Indicate the battery voltage, current, power.
	Indicate the grid voltage, current, power.
	Indicate the load voltage, current, power.
	Indicate the gen.(The icon is not displayed when the gen's voltage is below 50V.)
	History Error Icon. By clicking this icon, you can enter History Error Page which show History Error Code.
00/00/2000 00:00:00	The data and local time that must be set during commissioning.
	Page screen which including Battery Stetting1,Battery Stetting 2, Battery Stetting 3,Work Mode, Time Of Use ,Grid Setting, Basic Setting ,History Error.
SUB	Work mode.
	Indicate the CT power.(The icon is not displayed when the extern CT is not be choosed.)

The main screen includes the icons for PV (left up), grid (right up), load (right bottom) and battery (left bottom). It also displays the energy flow direction by moving dots.

Some clarifications about the system status are as follows:

- 1.PV power will always be positive.
- 2.In single inverter system, load power will always be positive.
- 3.A negative Grid power means energy being exported to the grid (sold), whereas positive means energy being imported form the grid (purchased).
- 4.Negative battery power means charge, positive means discharge.

### 5.4 LCD operation flow chart

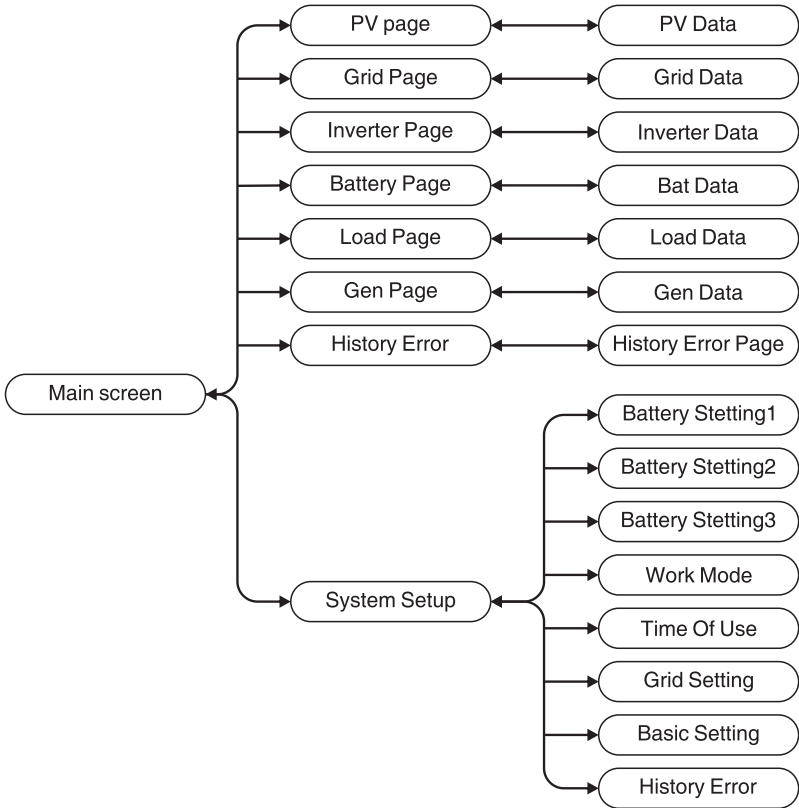

### 5.5 LCD Display Setting



#### 5.5.1 Detail Page

Click the icon on the screen of LCD display, you can enter the detail page of PV, Grid, inverter Bat, and Load.

LCD display	Description
	<p>This is PV panel data page.</p> <ol style="list-style-type: none"> <li>1. Voltage, current, power of each MPPT.</li> <li>2. Daily and total production.</li> <li>3. PV power curve for hour, daily, monthly, yearly.</li> </ol>

	<p>This is grid data page.</p> <ol style="list-style-type: none"> <li>1.Voltage, current, power, frequency, of grid.</li> <li>2.You can choose sell or buy. It will show you sell today and sell total production or buy today and buy total production. Sell: Energy from inverter to grid. Buy: Energy from grid to inverter.</li> <li>3.Grid power curve for hour, daily, monthly, yearly.</li> </ol>
	<p>This is inverter data page.</p> <ol style="list-style-type: none"> <li>1.INV BUS, INV HBUS voltage, leakcurrent, INV power and INV state.</li> <li>2.Air temperature, INV temperature, PV temperature, LLC temperature, Charge temperature.</li> <li>3.Turn on the machine button. Holding the button 2 seconds, it will turn off the machine.</li> </ol>
	<p>This is bat data page.</p> <ol style="list-style-type: none"> <li>1.Bat voltage, charge current, discharge current, power.</li> <li>2.Li-BMS.</li> </ol>
	<p>This is load data page.</p> <ol style="list-style-type: none"> <li>1.Load voltage, current, power frequency.</li> <li>2.Daily and total production.</li> <li>3.Load power curve for hour, daily, monthly, yearly.</li> </ol>
	<p>This is gen data page.</p> <ol style="list-style-type: none"> <li>1.Gen voltage, current, power, frequency.</li> <li>2. Daily and total production.</li> </ol> <p>(*Note: The generator is operating in single mode.)</p>

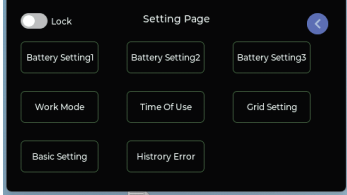
5.5.2 System Setting Page

LCD display	Description
	<p>This is system setting menu page.</p>
	<p>When we flip the “Lock” switch, access to system settings asks us to enter a password. Password: 123456</p>

5.5.3 Battery Setting Page

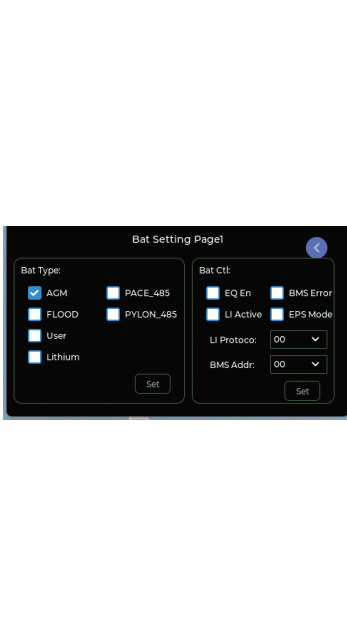
LCD display	Description
	<p>This is Bat Setting Page1.</p> <p><b>User:</b> If “User-Define” is selected, battery charge voltage and under voltage can be setup.</p> <p><b>PACE_485:</b> If selected “Lithium” battery communication connection for PACE 485 BMS.</p> <p><b>PYLON_485:</b> If selected, Lithium battery communication connection for PYLON_485 BMS.</p> <p><b>EQ En:</b> Battery equalization switch. Only effective when the battery type in “FLOOD” or “user” mode.</p> <p><b>BMS Error:</b> When the lithium battery fails ,turn off the machine.</p> <p><b>Lithium Active:</b> When the solar energy or Line exists, set this item to Lithium, and the lithium battery will be activated for 3 second.</p> <p><b>EPS Mode:</b> EPS Mode switch.</p> <p><b>LI Protocol:</b> This is the BMS communication protocol code. “00” is PYLON_485, “01” is PACE_485.</p>

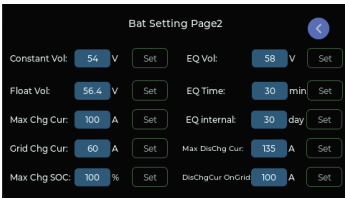

**Constant Voltage:** Bulk charging voltage. If “User” is selected in “Bat Setting Page1”, this program can be setup. Setting range is from 48.0V to 60.0V.(default:56.4V)

**Float Voltage:** Battery full charging voltage. If “User” is selected in “Bat Setting Page1”, this program can be setup. Setting range is from 48.0V to 60.0V.(default:54V)

**Maximum Charging Current:** To configure total charging current for solar and utility chargers. Setting range is from 10A to135A for 6KW model,10A to135A for 7KW model,10A to 190A for 8KW model,10A to 220A for 10KW model,10A to 250A for 12KW model. (default:100A)

**Grid Charging Current:** Maximum utility charging current. Setting range is from 2A to 135A.(default:60A)

(\*Note: If setting value maximum charging current is smaller than that grid charging current, the inverter will apply charging current from maximum charging current for utility charger.)

**Max Charging Soc:** The maximum lithium charging soc. If the charging soc of the lithium has reached the setting soc, the lithium will be stopped to charge. Setting range is from 80% to100%.(default:100%)

**Battery Equalization Voltage:** Setting range is from 48.0V to 60.0V.(default:58V)

**Battery Equalized Timeout:** Setting range is from 5 min to 900 min.(default:30 min)

**Equalization Interval:** Setting range is from 0 to 90 days.(default:30 days)

**Discharging Current:** Battery maximum discharge current. Setting range is from 10 A to 135A for 6KW model,10 A to135A for 7KW model,10 A to190A for 8KW model,10 A to 220A for 10KW model,10 A to 250A for 12KW model.(default:135A)

**Dischgcure onGrid:** the limit discharge current when Grid power is available and work mode is “self”. When grid power is available it will use the smaller between“Dischgcure” and “Dischgcure onGrid” to limit the battery discharge current.Setting range is from 10 A to 135A for 6KW model,10 A to 135A for 7KW model,10 A

	<p>to 190A for 8KW model, 10 A to 220A for 10KW model, 10 A to 250A for 12KW model. (default: 100A) (*Note: If the battery discharge current over the setting max discharge current, overload will be reported after 10 seconds.)</p>
	<p><b>Under Voltage/Under SOC:</b> Low DC cut-off voltage/SOC. If “user” is selected in “Bat Setting Page1”, under voltage can be setup. Under Voltage Setting range is from 40.0V to 52.0V. (default: 42V) When the “Lithium” mode is selected, the lithium SOC is smaller than setting percentage, the machine will be turn off the output in off grid mode. After turning off the output and you want to restart, the SOC of the lithium battery should be 10% larger than the setting value. Setting range is from 5% to 90%. (default: 10%) Low DC cut-off voltage will be fixed to setting value no matter what percentage of load is connected.</p> <p><b>Stop Discharge Voltage/Stop Discharge SOC:</b> Setting voltage/SOC point back to utility source when selecting “SBU priority” or “MKS” in “Work mode setting”. In SUB or selfuse mode will allow battery to discharge. Stop Discharge Voltage setting range is from 42V to 52.5V. (default: 46V) Stop Discharge SOC setting range is from 5% to 90%. (default: 20%)</p> <p><b>Re-Discharge voltage/Re-discharge SOC:</b> Setting voltage/SOC point back to battery mode when selecting “MKS” or “SBU” in “work mode setting”. Re-Discharge voltage setting range is from 48V to 58V. (default: 54V) Stop Discharge SOC setting range is from 10% to 95%. (default: 80%)</p> <p><b>EPS Off Voltage/EPS Off SOC:</b> “EPS Mode” is selected in “Bat Setting Page1”. When the battery voltage/SOC is smaller than “EPS off voltage/soc”, it will turn off the main load. After disconnecting the main output, if you want to reconnect it, the SOC of the lithium battery needs to be 10% larger than the setting value.</p>

	<p>EPS Off Voltage setting range is from 40V to 52V.(default:50V)          EPS Off Soc setting range is from 5% to 90%. (default:40%)          (*Note: if use Lithium battery refer to under SOC, stop discharge SOC, Re-discharge SOC, EPS off SOC, otherwise refer to under voltage, stop discharge voltage, Re-discharge voltage, EPS off voltage.)</p>
--	--

5.5.4 Work Mode Setting

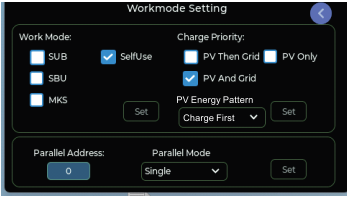
LCD display	Description
	<p><b>Work Mode</b></p> <p><b>SUB:</b> Solar energy provides power to the loads as first priority. If solar energy is not sufficient to power all connected loads, utility will supply power to the loads at the same time. (default)          Battery provides power to the loads only when any one condition happens:          -Solar energy and utility is not available.          -Solar energy is not sufficient and utility is not available.</p> <p><b>SBU:</b> Solar energy provides power to the loads as first priority. If solar energy is not sufficient to power all connected loads, battery energy will supply power to the loads at the same time. Utility provides power to the loads only when battery voltage drops to the “Stop-Discharge voltage”in “Bat setting page3” .</p> <p><b>MKS:</b> When solar is available, Refer to “SBU” mode; When solar is not available, refer to “SUB” mode.</p> <p><b>Selfuse:</b> When solar is available, solar and battery will supply power to the loads at the same time. If solar and battery energy are not sufficient to power all connected loads, utility will supply power to the loads. When solar is not available, battery will supply power to the loads.</p>

(\*Note 1: if opening the “Feed Grid Enable” in “Selfuse mode”, battery will sell the energy to grid.

\*Note 2: When in SBU /MKS mode and the PV system is unavailable, if you turn on the overload bypass function in WIFI app, when the battery discharge current exceeds the setting maximum battery discharge current, it will back to the grid mode.)

#### **Charge Priority**

**PV Than Grid:** Solar energy will charge battery as first priority. Utility will charge battery only when solar energy is not available.

**PV Only:** Solar energy will be the only charger source no matter utility is available or not.

**PV And Grid:** Solar energy and utility will charge battery at the same time.(default)

**PV Energy Pattern:** Priority of PV power usage. When in “Grid mode”, the default energy pattern is “Load first”, this setting will be valid.

**Charge First:** PV power is firstly used to charge the battery, and the excess power will be used to power the load. If PV power is insufficient, grid will make supplement for battery and load simultaneously.

**Load First:** PV power is firstly used to power the load, and the excess power will be used to charge the battery. If PV power is insufficient, Grid will provide power to the load.

**Parallel Mode:** If a set of inverters are connected to inverter 1, inverter 2, inverter 3, inverter 4, inverter 5, inverter 6, the function needs to be enabled.

(\*Note 1: This setting can only be set by stand by mode the switch after the secondary source is started.

\*Note 2: In parallel mode, the Max Chg SOC, the fifth timed grid charge and battery discharge, Time Set, clear PV Data, clear Load Data, clear Grid Data, GFCI Check, CT Enable, CT Radio Adj setting items will not synchronize to other machine.)

5.5.5 Time Of Use Page

LCD display	Description
	<p><b>Time Of Use:</b> It is used to program when to use grid to charge the battery, and when to discharge the battery to power the load. Only tick “TOU Enable” the follow items will take effect.</p> <p><b>Grid Charge:</b> Use the grid to charge the battery in the selected period of time.</p> <p><b>Bat Discharge:</b> Battery will supply power to the loads in the selected period of time.</p> <p>(*<b>Note 1:</b> When in “SBU” or “MKS” mode, click “Bat Discharge” and “TOU Enable”, battery will supply power to loads in off grid mode.</p> <p>*<b>Note 2:</b> When in “Selfuse” mode, click “Bat Discharge” and “TOU Enable”, utility will supply power to loads. If choose the “Sell Power To Grid” in “Grid setting page”, battery will sell the energy to grid.)</p>

5.5.6 Basic Setting Page

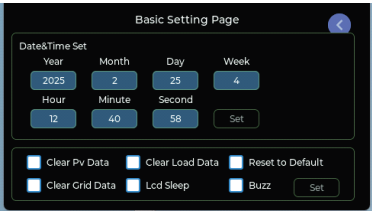
LCD display	Description
	<p><b>Data&amp;Time Set:</b> Enable the inverter to automatically synchronize cloud platform time.</p> <p><b>Clear PV Data:</b> Clear all PV power generation.</p> <p><b>Clear Load Data:</b> Clear all Load power generation.</p> <p><b>Reset To Default:</b> Reset all parameters of the inverter.</p> <p><b>Clear Grid Data:</b> Clear all Grid power generation.</p> <p><b>LCD Sleep:</b> If check this box, LCD will sleep after 3min.</p> <p><b>Buzz:</b> Used to turn on or off the beep sound in inverter’s alarm status.</p>

5.5.7 Grid Setting Page

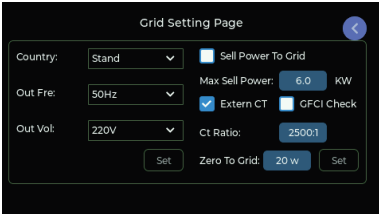
LCD display	Description
	<p><b>Country:</b> You can choose different country.</p> <p><b>Output Frequency:</b> You can choose 50Hz or 60Hz.(default:50Hz)</p> <p><b>Output Voltage:</b> Default output voltage is 230V. The output voltage is selectable:220V,230V, 240V.(default:230V)</p> <p><b>Sell Power To Grid:</b> Ticking the “Sell Power To Grid”, it will feed the power to grid.</p> <p><b>GFCI Check:</b> Tick “GFCI check”,the machine will check GFCI leak current.</p> <p><b>Extern CT :</b> Tick the “Extern CT”, it supports to connect the external CT.</p> <p><b>CT Ratio:</b> CT ratio setting. You can set different ratios to adapt to different Cts. Setting range is from 100:1 to 30000:1(default:2500:1)</p> <p><b>Zero To Grid:</b> It tells the grid output power. Recommend to set it as 20-100W to ensure the inverter won't feed power to grid. Setting range is from 0W to 500W.(default:20W)</p> <p>(*<b>Note:</b> when “Extern CT” function is on, if the load power is negative, check whether the CT direction is connected in reverse.)</p>

5.5.8 History Error Page

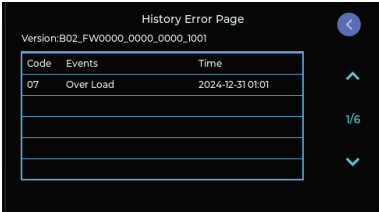
LCD display	Description
	<p>This page show software version number and history error code.</p>

**5.6 Fault Reference Code**

Fault Code	Fault Event	Description
01	Fan Lock.	Fan is lock when inverter is on.
02	Over Temp.	Over temperature.
03	Bat Vol High.	Battery voltage is too high.
05	Output Short.	Output Short circuited.
06	Output Vol High.	Output voltage is too high.
07	Over Load.	Over load(note:if the alarm is overloaded over three time,the machine will not startagain.)
08	Bus Vol Over.	Bus voltage is over.
12	Soft Start Fail.	Soft start fail.
15	Internal SCI Fail.	Internal communication fault.
17	LLC Fault.	LLC short-circuit.
18	BMS Error.	Lithium communication fault.
19	PV current over.	PV current is over.
21	GFCI Fault.	Leakage current fault.
23	PV ISO Fault.	PV isolation resistance is too low.
25	RELAY Check Fault.	Relay self-check failed.
51	Over Current.	Over current or surge.
52	Bus Vol Under.	Bus voltage is too low.
53	Inv Soft Fail.	Inverter soft start fail.
55	Load DC Vol Over.	Over DC voltage in Ac output.
57	Current Hall Fault.	Current sensor failed.
58	Output Vol Under.	Output voltage is too low.
59	PV Vol Over.	PV voltage is over limitation.
60	Parallel Neg Power.	Parallel failure.
71	Parallel Version Diff.	Parallel version is inconsistent.
75	Parallel Setting Fault.	Parallel Settings are inconsistent.
80	Parallel CAN Loss.	Parallel communication failure.
81	Host Line Loss.	Host signal Loss.
82	Syn phase Loss.	Synchronization signal Loss.
86	Parallel Mode Diff.	Parallel mode is incorrect.
99	Other Fault.	Other fault.

### 5.7 Warning Indicator

Warning Event	Audible Alarm	Icon Flashing
Low battery.	Beep once every second.	Battery low warning.
Overload .	Beep once every second.	Overload.
The battery is being activated.	Beep once every second.	Battery active.
Battery is equalizing.	Beep once every second.	Battery equalized.
BMS no communication.	Beep once every second.	BMS no communication.
PV energy weak.	Beep once every second.	PV weak warning.
Battery energy weak.	Beep once every second.	Battery weak warning.
CT not connected.	Beep once every second.	CT not connected.
CT wrong direction.	Beep once every second.	CT wrong direction.

## 6.SPECIFICATIONS

**Table 1 Line Mode Specifications**

INVERTER MODEL	6KW	7KW	8KW	10KW	12KW
Input Voltage Waveform	Sinusoidal (utility or generator)				
Nominal Input Voltage	230Vac				
Low Loss Voltage	170Vac±7V(UPS)				
Low Loss Return Voltage	180Vac±7V(UPS)				
High Loss Voltage	280Vac±7V				
High Loss Return Voltage	258Vac±7V				
Max AC Input Voltage	300Vac				
Nominal Input Frequency	50Hz/60Hz(Auto detection)				
Low Loss Frequency	45±1Hz				
Low Loss Return Frequency	46±1Hz				
High Loss Frequency	65±1Hz				
High Loss Return Frequency	63±1Hz				
Output Short Circuit Protection	Circuit Breaker				
Efficiency(Line Mode)	>95%( Rated R load, battery full charged )				
Transfer Time	10ms typical (Single mode)				

**Table 2 Inverter Mode Specifications**

INVERTER MODEL	6KW	7KW	8KW	10KW	12KW
Rated Output Power	6KW	7KW	8KW	10KW	12KW
Output Voltage Waveform	Pure Sine Wave				
Output Voltage Regulation	230Vac±5%				
Output Frequency	50Hz/60Hz				
Peak Efficiency	93%				
Overload Protection	3s@ ≥ 150% load; 5s@ 101%~150% load				
Surge Capacity	2* rated power for 5 seconds				
Nominal DC Input Voltage	48.0Vdc				
Cold tart Voltage	46.0Vdc				
Low DC Warning Voltage @ load < 50% @ load ≥ 50%	44.0Vdc 42.0Vdc				
Low DC Warning Return Voltage @ load < 50% @ load ≥ 50%	45.0Vdc 44.0Vdc				

Low DC Cut-off Voltage @ load < 50% @ load ≥ 50%	41.0Vdc 40.0Vdc
High DC Recovery Voltage	62.0Vdc
High DC Cut-off Voltage	63.0Vdc
No Load Power Consumption	75W

**Table 3 Two Load Output Power**

INVERTER MODEL	6KW	7KW	8KW	10KW	12KW
Full Load	6000W	7000W	8000W	10000W	12000W
Maximum Main Load	6000W	7000W	8000W	10000W	12000W
Maximum Second Load (battery model)	4200W	4200W	5600W	7000W	8400W
Main Load Cut off Voltage	50Vdc				
Main Load Return Voltage	54Vdc				

**Table 4 Charge Mode Specifications**

Utility Charging Mode					
INVERTER MODEL	6KW	7KW	8KW	10KW	12KW
Charging Algorithm	3-Step				
AC Charging Current (Max)	135A	135A	190A	220A	250A
Bulk Charging Voltage	Flooded Battery		58.4Vdc		
	AGM / Gel Battery		56.4Vdc		
Floating Charging Voltage	54.0Vdc				

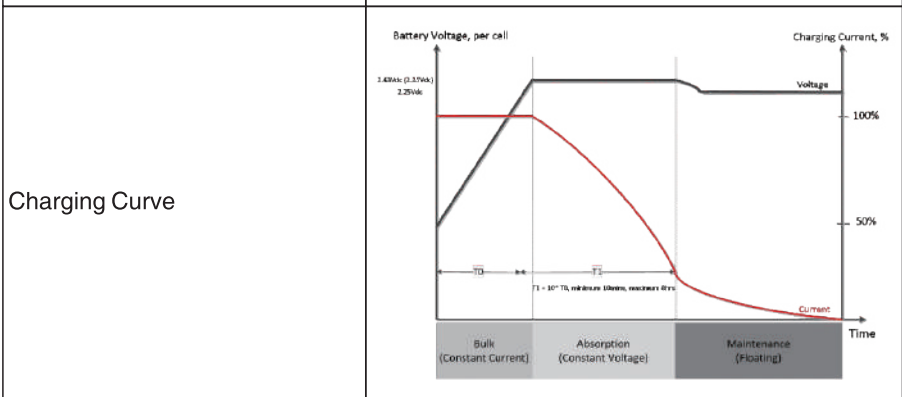

MPPT Solar Charging Mode					
INVERTER MODEL	6KW	7KW	8KW	10KW	12KW
Max.PV Array Power	PV1 Channel:4500W				
	PV2 Channel:4500W				
	/	PV3 Channel:4500W			
IMax.PV	PV1 Channel:18A				
	PV2 Channel:18A				
	/	PV3 Channel:18A			
Nominal PV Voltage	360Vdc				
PV Array MPPT Voltage Range	50Vdc~500Vdc				
Max. PV Array Open Circuit Voltage	520Vdc				
Max Charging Current(AC charger plus solar charger)	135Amp	135Amp	190Amp	220Amp	250Amp

**Table 5 Grid-Tie Operation**

INVERTER MODEL	6KW	7KW	8KW	10KW	12KW
Nominal Output Voltage	220/230/240Vac				
Feed-in Grid Voltage Range	195.5Vac~253Vac				
Feed-in Grid Frequency Range	49Hz~51Hz				
Nominal Output Current	26.5A	26.5A	35A	43.5A	65.5A
Power Factor Range	>0.99				
Maximum Conversion Efficiency (DC/AC)	98%				

**Table 6 General Specifications**

INVERTER MODEL	6KW	7KW	8KW	10KW	12KW
Safety Certification	CE				
Operating Temperature Range	-10°C ~ 50°C				
Storage temperature	-15°C~ 60°C				
Humidity	5% to 95% Relative Humidity(Non-condensing)				

## 7.TROUBLE SHOOTING

Problem	LCD/LED/Buzzer	Explanation /Possible cause	What to do
Buzzer beeps continuously and red LED is on.	Fault code 01	Fan fault.	Replace the fan.
	Fault code 02	The temperature exceeds the protection point.	Check whether the air flow of the unit is blocked or whether the ambient temperature is too high.
	Fault code 05	Output short circuited.	Check if wiring is connected well and remove abnormal load.
	Fault code 06/58	Output abnormal. (Inverter voltage below than 190Vac or is higher than 260Vac.)	1. Reduce the connectedload. 2. Return to repair center.
	Fault code 07	Overload error. The inverter is overload 102% and time is up.	Reduce the connected load by switching off some equipment.
	Fault code 08/53/57	Internal components failed.	Return to repair center.
	Fault code 51	Over current or surge.	Restart the unit, if the error happens again, please return to repair center.
	Fault code 52	Bus voltage is too low.	
Fault code 55	Output voltage is unbalanced.		

## APPENDIX I: PARALLEL FUNCTION

### 1.INTRODUCTION

This inverter can be used in parallel with two different operation modes.

- 1.Parallel operation in single phase is with up to 6 units. The supported maximum output power is 36 KW/36 KVA.
- 2.Three-phase parallel, up to three units working together.

### 2.MOUNTING THE UNIT

When installing multiple units, please follow below chart.

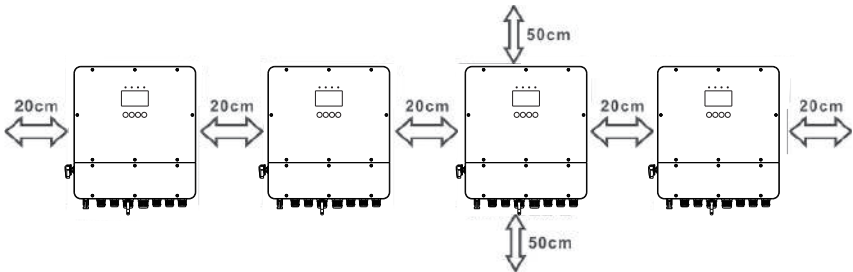

\*NOTE:

For proper air circulation to dissipate heat, allow a clearance of approx, 20 cm to the side and approx. 50 cm above and below the unit. Be sure to install each unit in the same level.

### 3.WIRING CONNECTION

When installing multiple units, please follow below chart.

The cable size of each inverter is shown as below:

Recommended battery cable and terminal size for each inverter:

Ring terminal:

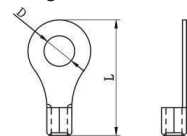

MODEL	Wire size	Cable (mm <sup>2</sup> )	Torque value(max)
6KW/7KW/8KW/10KW/12KW	1 x 2AWG	25	2N · m

Recommended AC input and output cable size for each inverter:

MODEL	Wire size	Cable (mm <sup>2</sup> )	Torque value(max)
6KW/7KW/8KW/10KW/12KW	10AWG	6	1.2N · m

You need to connect the cables of each inverter together, Take the battery cables for example: You need to use a connector or bus-bar as a joint to connect the battery cables together, and then connect to the battery terminal. The cable size used from joint to battery should be X times cable size in the tables above. "X" indicates the number of inverters connected in parallel.

Regarding AC input and output, please also follow the same principle.

**⚠ WARNING**

- It's REQUIRED to connect battery for parallel operation.
- Be sure the length of all battery cables is the same. Otherwise, there will be voltage difference between inverter and battery to cause parallel inverters not working.

**⚠ CAUTION**

- Please install the breaker at the battery and AC input side. This will ensure the inverter can be securely disconnected during maintenance and fully protected from over current of battery or AC input.

Recommended breaker specification of battery for each inverter:

MODEL	6KW	7KW	8KW	10KW	12KW
1 unit*	51.2V 135Ah	51.2V 135Ah	51.2V 200Ah	51.2V 300Ah	51.2V 300Ah

Recommended breaker specification of AC input with single phase:

MODEL	6KW	7KW	8KW	10KW	12KW
1 unit*	40A/230Vdc	40A/230Vdc	63A/230Vdc	63A/230Vdc	63A/230Vdc

\*Note 1:

If you want to use only one breaker at the output side for the whole system, the rating of the breaker should be X times current of 1 unit, "X" indicates the number of inverters connected in parallel.

Recommended battery capacity:

Inverter parallel numbers	2	3	4	5	6
Battery Capacity	200Ah	400Ah	400Ah	600Ah	600Ah

## 4. PARALLEL CONNECTION

### 4.1 Parallel Operation in Single phase

Two inverters in parallel:

Power Connection

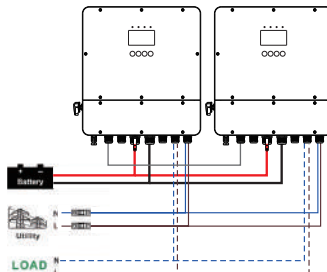

Communication Connection

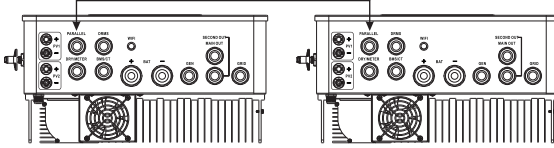

Three inverters in parallel:  
Power Connection

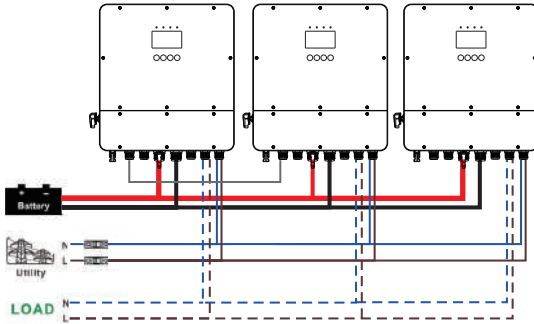

Communication Connection

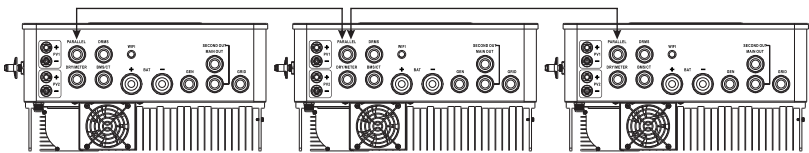

Four inverters in parallel:  
Power Connection

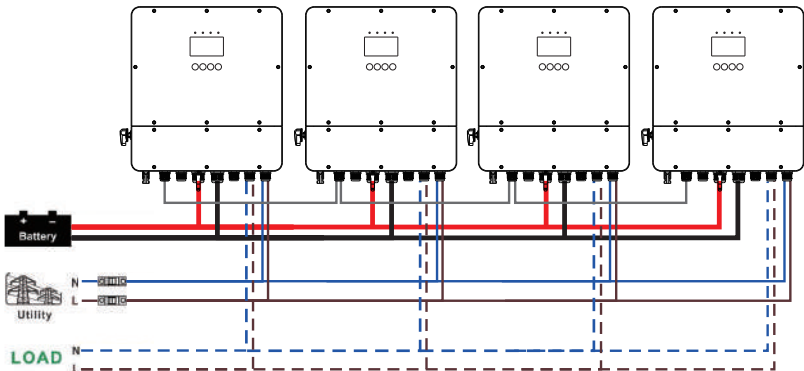

Communication Connection

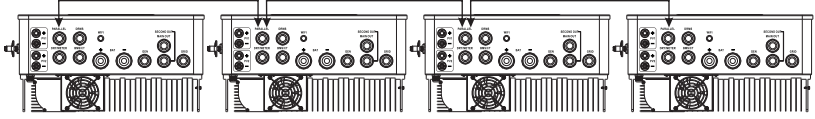

Five inverters in parallel:

Power Connection

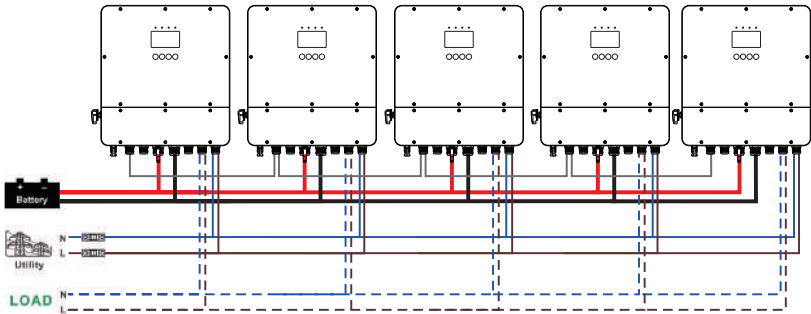

Communication Connection

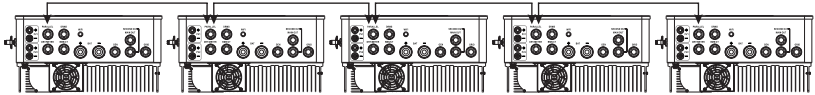

Six inverters in parallel:

Power Connection

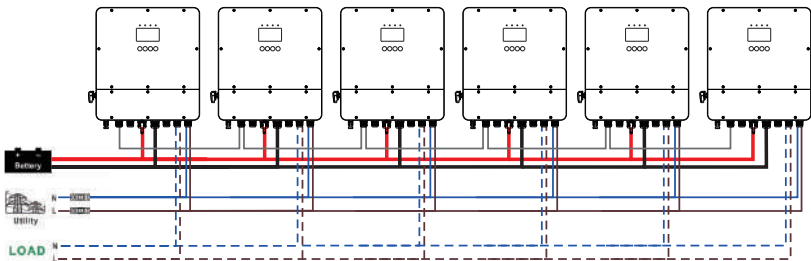

Communication Connection

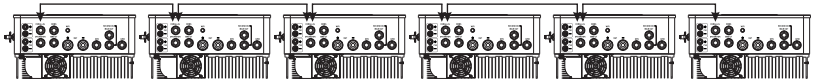

## 4.2 Support 3-phase equipment

One inverter per phase:

Power Connection

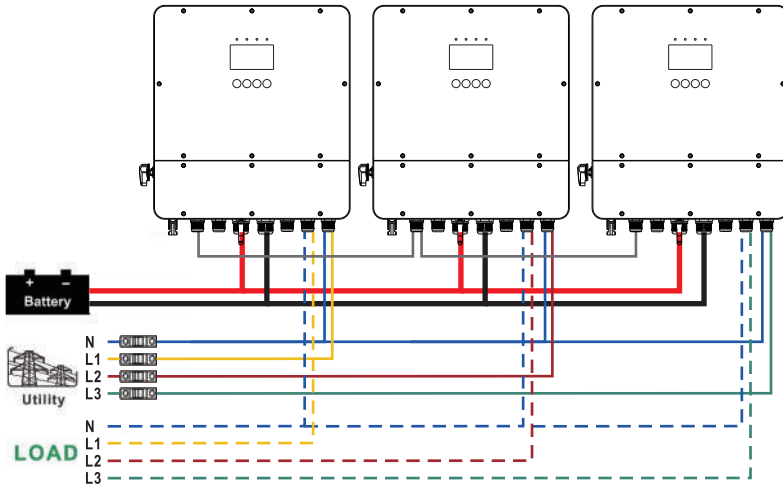

Communication Connection

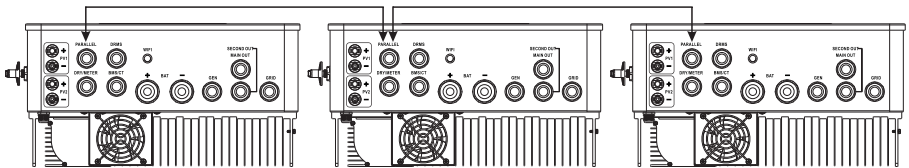

\*Note:

1. You need to connect all inverters to the “PARALLEL” port; otherwise, the inverters fail or are damaged.
2. If you need to increase the number of inverters in a phase, add “PARALLEL” as described above, and add other cables directly to the line of the phase.
3. Ensure that there is at least one inverter per phase before the machine can start output normally.
4. Single-phase parallel support six unit working together. Three-phase parallel only support three unit working together.
5. The first and the last of parallel inverter’s communication board’s “SW1” should be open, please set it to on.

## 5. PV CONNECTION





Please refer to user manual of single unit for PV Connection.

**! CAUTION**

- Each inverter should connect to PV modules separately.

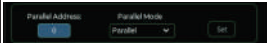
## 6. LCD SETTING AND DISPLAY

Setting Program:

Program	Description	Selectable option	
28	AC output mode*This setting is able to set up only when the inverter is in standby mode. Be sure that on/off switch is in "OFF" status.	Single	<p>When the unit is operated alone, please select "Single" in "Parallel Mode" in "work mode setting" page.</p> <p>When the units are used in parallel for single phase application, please select "Parallel" in "Parallel Mode" in "work mode setting" page.</p> <p>When the units are operated in 3-phase application, please choose "3PX" to define each inverter. Please select "3P-PhaseA" in "Parallel Mode" for the inverters connected to L1 phase, "3P-PhaseB" in "Parallel Mode" for the inverters connected to L2 phase and "3P-PhaseC" in "Parallel Mode" for the inverters connected to L3 phase.</p>
			
		Parallel	
			
		3P-PhaseA:	
			
			
3P-PhaseB:			
			
3P-PhaseC:			
			

## 7.COMMISSIONING

### 7.1 Parallel in single phase

Step 1: Check the following requirements before commissioning:

- Correct wire connection.
- Ensure all breakers in Line wires of load side are open and each Neutral wires of each unit are connected together.

Step 2: Turn on each unit and set “Parallel” in “Parallel Mode” in “work mode setting” page of each unit. And then shut down all units.

\*NOET:

It's necessary to turn off switch when setting LCD program, Otherwise, the setting cannot be programmed.

Step 3: Turn on each unit.

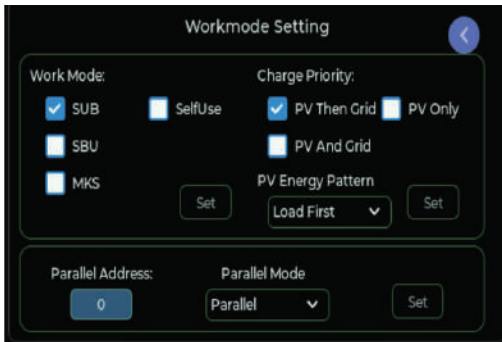

Step 4:

Switch on all Ac breakers of line wires in Ac input, It's better to have all inverters connect to utility at the same time. Otherwise, the mains of all inverters cannot be connected. The inverters can work properly only after the mains of all inverters are correctly connected. If detecting AC connection, they will work normally.

Step 5:

If there is no more fault alarm, the parallel system is completely installed.

Step 6:

Please switch on all breakers of Line wires in load side. This system will start to provide power to the load.

### 7.2 Support three-phase equipment

Step 1: Check the following requirements before commissioning:

- Correct wire connection.
- Ensure all breakers in Line wires of load side are open and each Neutral wires of each unit are connected together.

Step 2:

Turn on all units and configure LCD “Parallel Mode” in “work mode setting” page as 3P-PhaseA, 3P-PhaseB and 3P-PhaseC sequentially. And then shut down all units.

**\*NOET:**

It's necessary to turn off switch when setting LCD program. Otherwise, the setting cannot be programmed.

**Step 3:**

Turn on all units sequentially.

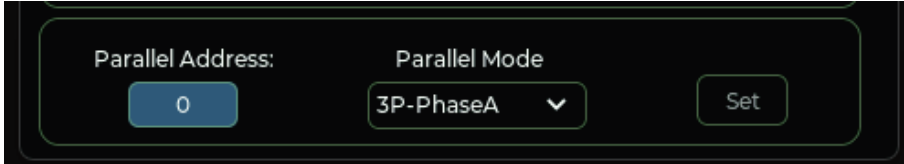

LCD display in L1-phase unit

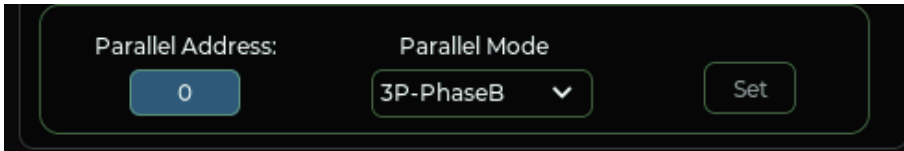

LCD display in L2-phase unit

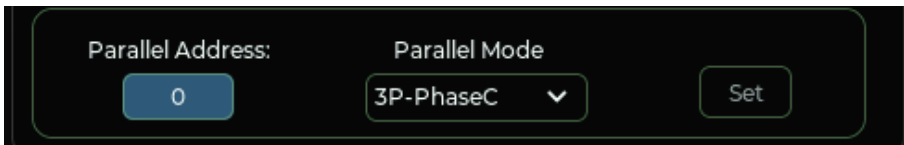

LCD display in L3-phase unit

**Step 4:**

Switch on all AC breakers of Line wires in AC input, If AC connection is detected and three phases are matched with unit setting, they will work normally. Otherwise, the mains will not be connected and will be connected after all the mains are matched.

**Step 5:**

If there is no more fault alarm, the system to support 3-phase equipment is completely installed.

**Step 6:**

Please switch on all breakers of Line wires in load side. This system will start to provide power to the load.

**\*Note 1:**

To avoid overload occurring, before turning on breakers in load side, it's better to have whole system in operation first.

**\*Note 2:**

Transfer time for this operation exists. Power interruption may happen to critical devices, which cannot bear transfer time.

## 8.TROUBLE SHOOTING

Situation		Solution
Fault Code	Fault Event Description	
71	The firmware version of each inverter is not the same.	1.Update all inverter firmware to the same version. 2.Check the version of each inverter via LCD setting and make sure the CPU versions are same. If not, please contact your instraller to provide the firmware to update. 3.After updating, if the problem still remains, please contact your installer.
75	Data synchroni- zation fault.	1.Check if communication cables are connected well and restart theinverter. 2.If the problem remains, please contact your installer.
80	CAN data loss.	
81	Host data loss.	
82	Synchronization data loss	
86	AC output mode setting is different.	1.Switch off the inverter and check LCD setting “Parallel Mode”. 2.For parallel system in single phase, make sure no 3P-PhaseA, 3P-PhaseB and 3P-PhaseC are setted on “Parallel Mode”.For supporting three-phase system, make sure no “Parallel” is set on “Parallel Mode”. 3.If the problem remains, please contact your installer.

## APPENDIX II: WIFI CONNECTION INSTRUCTIONS

### 1.WIRELESS WI-FI DISTRIBUTION NETWORK

#### 1.1 APP Download

Method 1:

Scan the QR code on the right, download the app.

Method 2:

Scan the QR code of the film on the collector.

Method 3:

Search in the application market to download the APP named “SUN WISE” for download.



#### 1.2 Registered Account

On the App home page, click the “Sign Up” button,fill in the relevant information according to the prompt, and complete the registration.

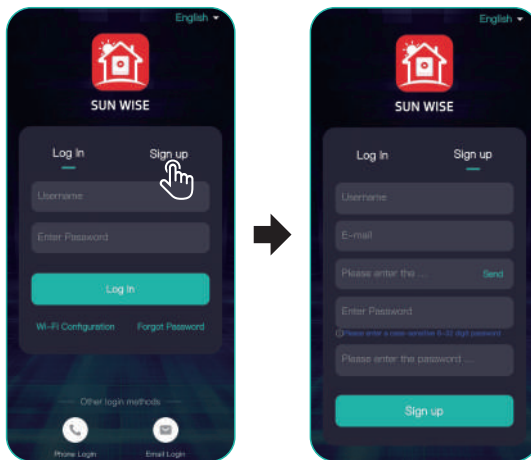

## 2.SUPPORTING NETWORK AND ADDING DEVICE

### 2.1 Wi-Fi Collector Connection Router

1.After the PWR indicator on the collector is on, turn on the mobile phone Bluetooth and SUN WISE App, click the“Wi-Fi Configuration” button to enter the “Searching” page, and the page will automatically display the nearby Bluetooth device.

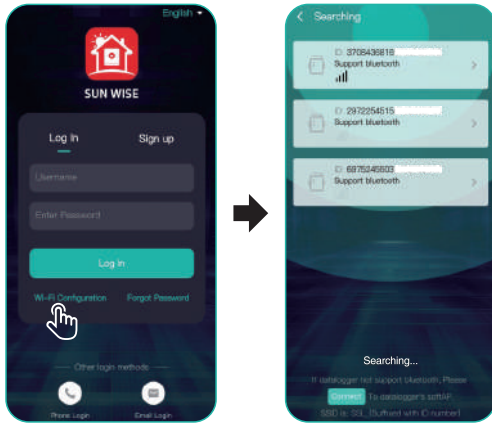

2. Select the collector that needs to be distributed, enter the matching webpage, and click the search icon, you can choose the Wi-Fi hotspot name.

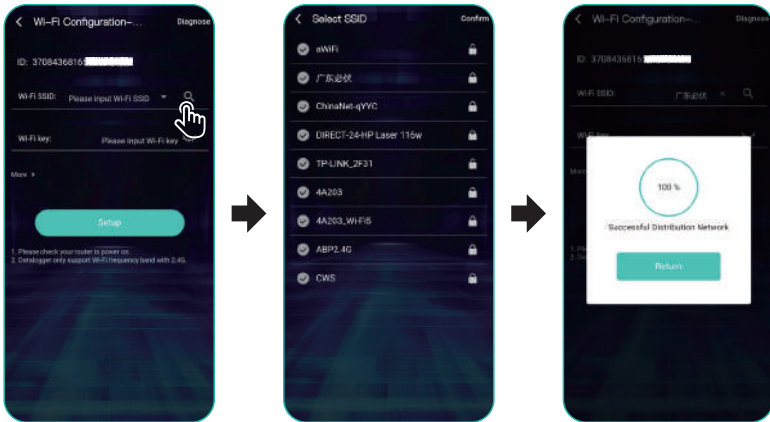

## 2.2 Add Device

Method 1:

1. Enter the homepage of the APP, click “+” in the upper right corner, enter the device to add the page, close the mobile phone close to the device, and the app scan the device automatically.
2. After scanning to the device, select the ID that is consistent with the ID of the collector tag, and click “Add”.

\*Note: Please confirm the collector ID before scanning. If the ID information is not found on the surface of the machine, you can view the ID on the matching page.

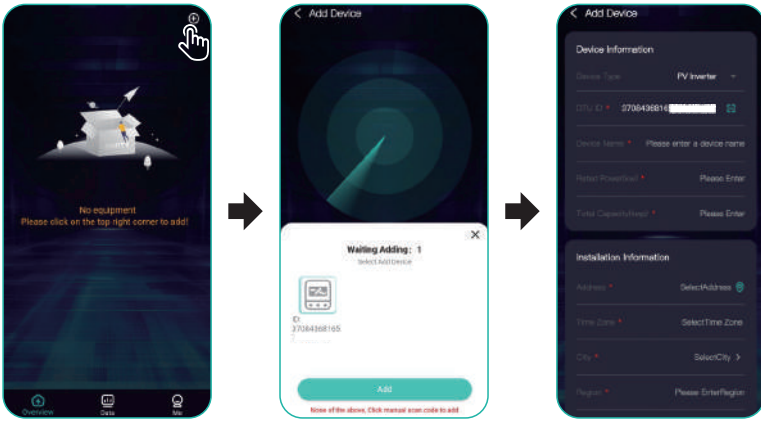

Method 2:

“Manually Add”, complete the adding device according to the interface prompt manual output collector ID, name and other information.

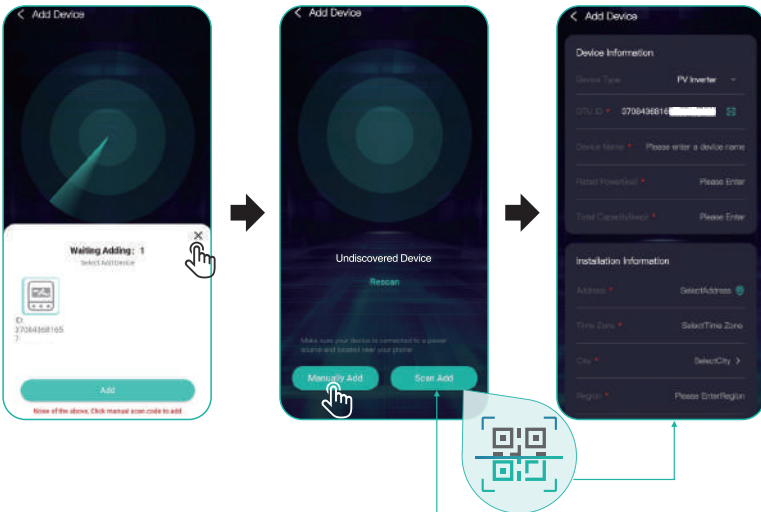

Method 3:

“Scan Add”, scan the QR code ID number of the collector film, and perform the device with the corresponding collector.

### 3.COLLECTOR FAULT DIAGNOSE AND INDICATOR LIGHT JUDGMENT

#### 3.1 Collector Fault Diagnose

After the device distribution network is completed or failed, you can make a failure diagnosis by clicking on the upper right "Diagnose".

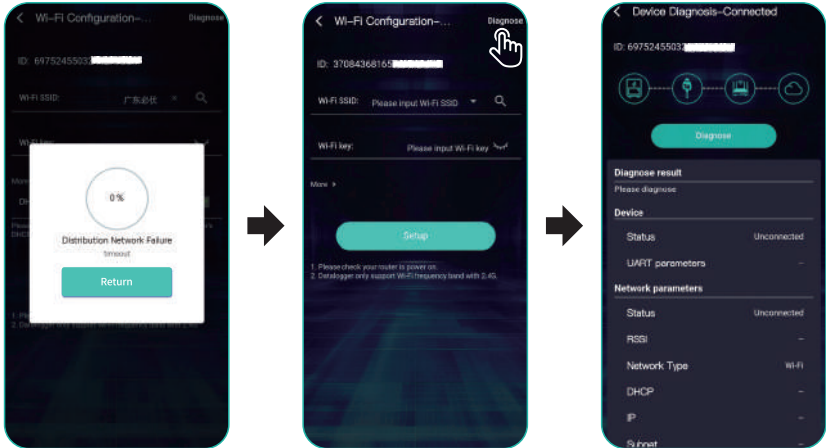

#### 3.2 Collector Indicator Status

1.PWR (power indicator light):

On: normal power supply.

Off: abnormal power supply.

2.COM (serial port transmission indicator):

Off: Number of data interaction.

Off for 0.3 seconds, on for 0.9 seconds: serial output data.

Off for 0.3 seconds, on for 0.3 seconds: serial port receiving data.

On: Bi-directional transfer.

3.Net (network status indicator):

Off for 0.3 seconds, on for 3 seconds: STA mode connects the upper router.

Off for 0.3 seconds, on for 0.3 seconds: STA is not connected to the upper router.

4.SRV (server connection indicator):

On: Has been connected to the server.

Off: Uninterrupted to the server.